

## DEALER NETWORK

**NETWORK  
ACROSS 362 CITIES  
PAN-INDIA**

### EXCLUSIVELY FOR YOU

- ENJOY WARRANTY UP TO 3 YEARS / 1 00 000 KM
- EXTENDED WARRANTY UP TO 5 YEARS / 2 20 000 KM
- GET A PERIODIC SERVICE IN JUST 60 MINS VIA EXPRESS MAINTENANCE
- BE ASSURED WITH 24-HOUR ROADSIDE ASSISTANCE
- BOOK YOUR SERVICE IN JUST A FEW CLICKS

**650 Total Touchpoints**

\* Toyota Sales & Service network as on 1<sup>st</sup> May 2024.  
\*\* Map and locations are indicative only. Not to be considered as actuals.



Scan to  
Explore More



For more information, visit [www.toyotabharat.com](http://www.toyotabharat.com) You can Talk to Toyota at 1800-309-0001 (BSNL/MTNL Toll Free No.) or +91-80-45059000 (Direct No.)

Note: Exterior features shown are not standard items and are available as Toyota Genuine Accessories. Vehicles pictured and specifications detailed in this brochure may vary between models and equipment. Addition of extra features may change figures in this chart. Toyota Kirloskar Motor Pvt. Ltd. reserves the right to alter the details of specifications and equipment without a notice. Actual colour of the vehicle body & upholstery might differ slightly from the images depicted in this brochure. Features are grade specific.

[/ToyotaIndia](#)

[/Toyota\\_India](#)

[/toyota.india](#)

[/ToyotainIndia](#)

Is your Innova Crysta Dealer



# BOLD NEW STYLE IMPOSING NEW PRESENCE

INTRODUCING THE INNOVA CRYSTA IN A NEW AVATAR



**INNOVA  
CRYSTA**

UNMATCHED.  
UNRIVALED.  
*Awesome*

# UNMATCHED UNRIVALED

The Innova Crysta has been India's favourite family car for over 15 years. It has been followed by many, but matched by none. Its power, comfort and safety are unparalleled and part of automobile folklore.

Now the legendary Innova's capabilities are further enhanced with an imposing new front silhouette that gives it a bold stance like no other. The new Innova Crysta also gets stunning diamond-cut alloy wheels that project elegance. In short, the new Innova Crysta is in a league of its own.

Distinctly designed, its exterior body lines are only a prelude to the luxuries that's inside. Nothing can prepare you for the unbelievable space and plushness of its luxurious cabin.

Replete with cozy, leather\* reclining seats that give you more legroom, and ride quality that's second to none, the new Innova Crysta is truly beyond compare. Add to that its raw, yet refined power delivery and you have a car that gives you a truly unmatched and unrivalled travelling experience.

\*Mix of genuine and synthetic leather.



## Imposing Chrome Surround Piano Black Grille

New bold front grille with chrome surround and stylish CRYSTA embossed bumper

## Enticing Diamond-cut Alloys

Gives more elegance & presence to your drive

## Front Clearance Sonar with MID Indication

Ensures safe parking in tight spaces

## Piercing LED Headlamps

Improves visibility and enhances the confident stance

# UNMATCHED DESIGN



The new Innova Crysta's design is matchless. Thanks to its distinctly styled, bold front grille and bumper, it exudes unmistakable road presence that takes it miles ahead of the rest.

**Welcome Lamps** / Provides a warm welcome everytime you approach the new Innova Crysta



## Blue Illumination, 3-dimensional Combination Meter with Large TFT MID

Blue illumination, 3-dimensional combination meter with large TFT MID with drive information, cost calculator and telephone/navigation display adds to the car's intelligence



# UNRIVALED CONNECTIVITY



The elegant driver dashboard is the control centre of the new Innova Crysta. It features 20.32cm display with Android Auto and Apple CarPlay Connectivity, using your smartphone you can also access advanced connectivity\* features like Walk to Car, Geo Fencing & Real Time Vehicle Tracking.

Apple CarPlay | Android Auto  
| Access your favourite Apple and Android apps

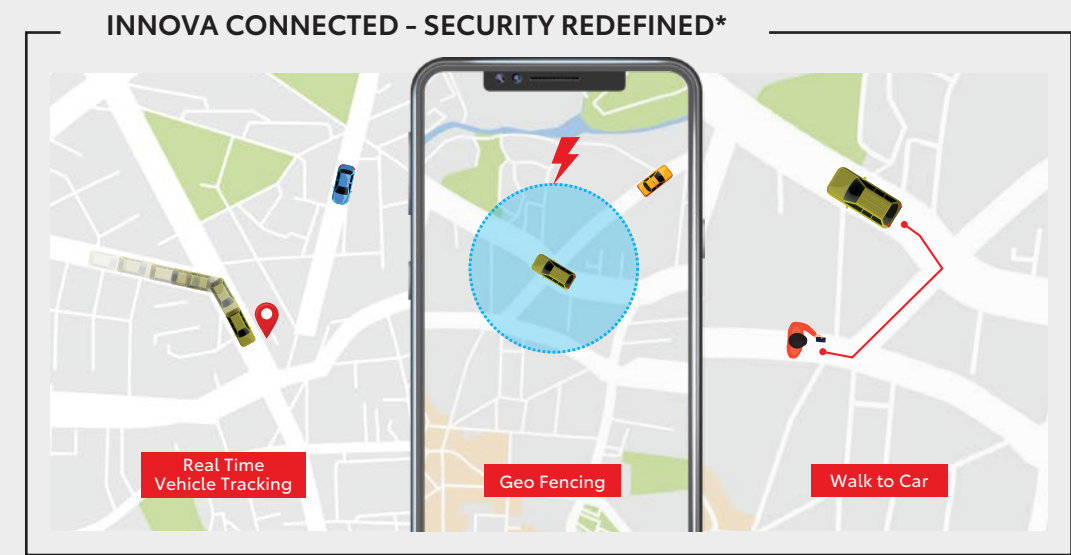

\*Recommended accessory. Not standard fitment. Illustrated parts may defer from actual vehicle subjected to improvements.

# UNMATCHED COMFORT



**Plush Leather<sup>#</sup> Seats** | Choose from a range of premium leather<sup>#</sup> seats in black and camel tan



**One-touch Tumble Second Row Seat** | Gives you easy access to the third row seats

The interior of the new Innova Crysta is unequalled in its refinement and class. While the sheer amount of space will thrill you, the built-to-last quality will mesmerise you. Be it the choice of premium leather<sup>#</sup> seats, enhanced legroom or soft-touch materials, the new Innova Crysta spells unparalleled comfort. So whether it's a long journey or a short trip, it gives you the calm and composure needed for you to arrive in style and confidence at your destination.



**Ambient Illumination** | Gives the cabin a luxurious look and feel



**Wood Finish Interior Panels** | Gives a premium and luxurious look

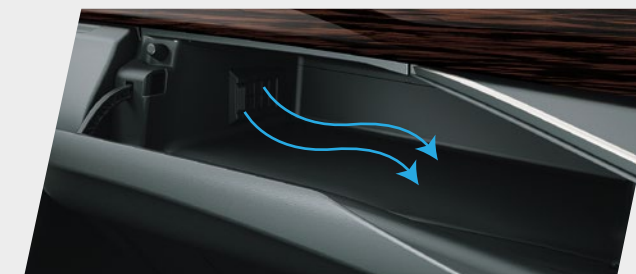

**Upper Glove Box with Cooling**  
| Keeps your beverages cold and refreshingly fresh



**Foldable Seatback Table with Cup Holder**  
| Keeps your knick knacks safely when on the go



**Easy Slide Front Passenger Seat**  
| Adjusts the rear legroom for more comfort



**Smartphone Holder with USB Port**  
| Keeps you connected when on the move

<sup>#</sup>Mix of genuine and synthetic leather.

# UNRIVALED PERFORMANCE



The new Innova Crysta has oodles of power under its hood, yet is unwaveringly efficient. And that's not all. It also offers refined driving dynamics for a smoother, more surefooted ride thanks to its robust chassis, sturdy suspension and slick transmission.



**ECO & POWER Drive Modes** | ECO mode for optimum fuel economy and POWER mode for sharper acceleration response



### Powerful GD Diesel Engine

The new Innova Crysta is powered by a GD diesel engine with further evolved low-speed torque. It has improved fuel economy while torque in the low and medium speed ranges have been considerably increased.



### Improved Suspension with Pitch & Bounce Control

Keeps cabin movement to a minimum and maintains a smooth ride on rough roads

# UNMATCHED SAFETY



The new Innova Crysta is not only powerful and comfortable, it's safe too. Because, at Toyota we give your safety the utmost priority.

The new Innova Crysta protects you and your family with 7 U SRS Airbags<sup>\*\*</sup> during any unforeseen event. Vehicle Stability control, Anti-lock braking, electronic brake force distribution, brake assist and the like ensure safety and stability even while high-speed braking.

The tough chassis and the acclaimed GOA Body keeps body roll to a minimum and ensures maximum protection by evenly distributing any impact on the car throughout the body of the car.

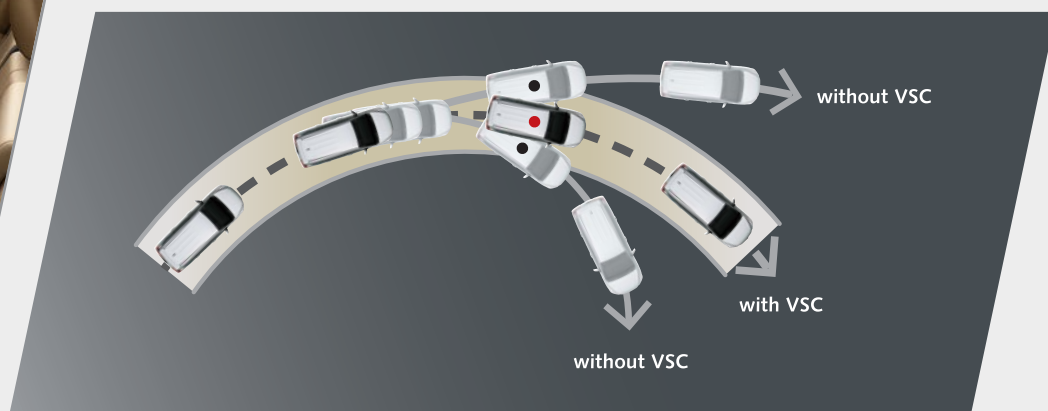

**Vehicle Stability Control** / Automatically controls both vehicle brakes and engine output during over steer or under steer while the vehicle is making a turn, ensuring vehicle stability

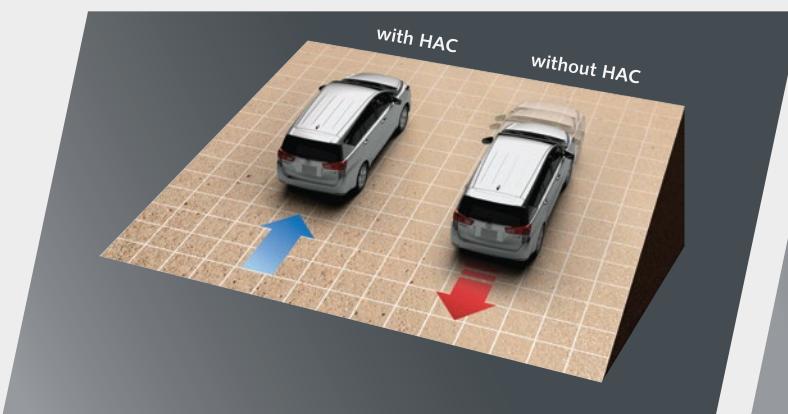

**Hill-start Assist Control** / Automatically controls the brakes suppressing vehicle rollback when starting off on a slope, reducing the burden on the driver

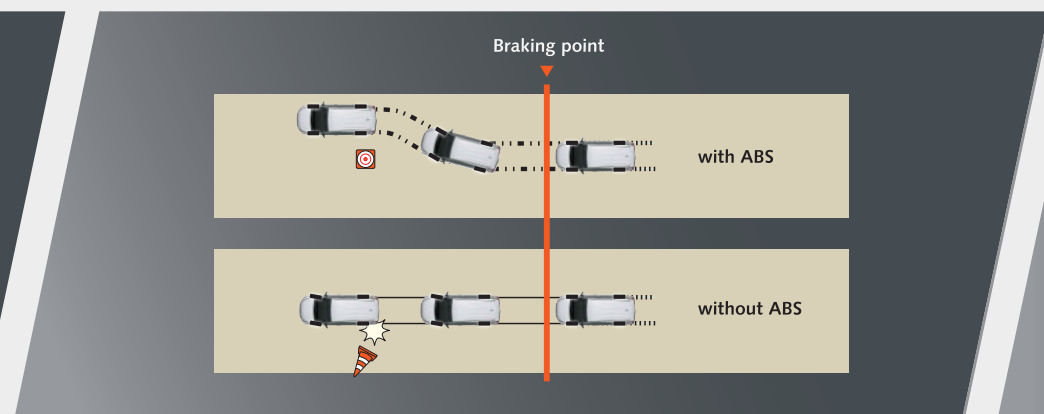

**Anti-lock Braking System** / Prevents wheels from locking and enables greater manoeuvrability and steering control

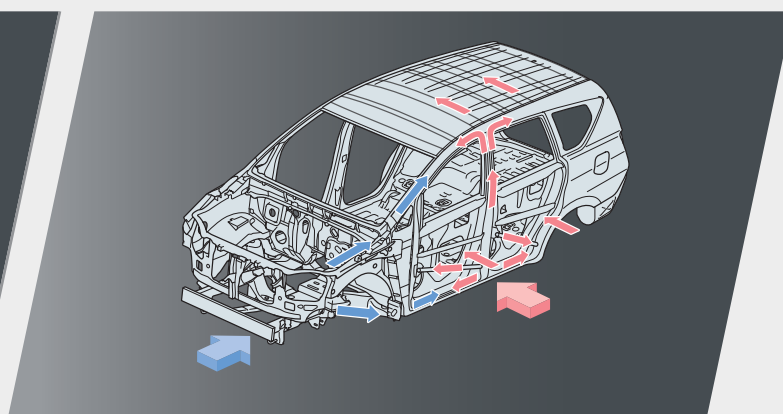

**GOA Body** / High strength body structure that effectively absorbs impacts and distributes it evenly during unforeseen collisions, thereby reducing passenger and pedestrian injuries

## SPECIFICATIONS

Grade	G	G	G	V	Z
	-	X	X+	X	X
	Manual	Manual	Manual	Manual	Manual
<b>FUEL TYPE*</b>	<b>DIESEL</b>	<b>DIESEL</b>	<b>DIESEL</b>	<b>DIESEL</b>	<b>DIESEL</b>
Seating Capacity	7 / 8 N Seater	7 / 8 N Seater	7 / 8 N Seater	7 / 8 N Seater	7 Seater
<b>ENGINE, TRANSMISSION &amp; CHASSIS</b>					
Displacement	0.002393m <sup>3</sup> (2393cm <sup>3</sup> )	0.002393m <sup>3</sup> (2393cm <sup>3</sup> )	0.002393m <sup>3</sup> (2393cm <sup>3</sup> )	0.002393m <sup>3</sup> (2393cm <sup>3</sup> )	0.002393m <sup>3</sup> (2393cm <sup>3</sup> )
Drive Modes	ECO & Power Mode	ECO & Power Mode	ECO & Power Mode	ECO & Power Mode	ECO & Power Mode
Max. Output	110kW (150PS) @ 56.66 s <sup>-1</sup>	110kW (150PS) @ 56.66 s <sup>-1</sup>	110kW (150PS) @ 56.66 s <sup>-1</sup>	110kW (150PS) @ 56.66 s <sup>-1</sup>	110kW (150PS) @ 56.66 s <sup>-1</sup>
Max. Torque	343 Nm (35.0 kg-m) @ 23.33 – 46.66 s <sup>-1</sup>	343 Nm (35.0 kg-m) @ 23.33 – 46.66 s <sup>-1</sup>	343 Nm (35.0 kg-m) @ 23.33 – 46.66 s <sup>-1</sup>	343 Nm (35.0 kg-m) @ 23.33 – 46.66 s <sup>-1</sup>	343 Nm (35.0 kg-m) @ 23.33 – 46.66 s <sup>-1</sup>
Transmission	5 Speed Manual	5 Speed Manual	5 Speed Manual	5 Speed Manual	5 Speed Manual
Tyres	205/65 R16 (40.64cm), Steel Wheels***	205/65 R16 (40.64cm), Steel Wheels***	205/65 R16 (40.64cm), Alloy Wheels***	205/65 R16 (40.64cm), Alloy Wheels***	215/55 R17 (43.18cm) Alloy Wheels
<b>EXTERIOR</b>					
Radiator Grille	New Design Black	New Design Black & Silver	New Design Black & Silver	New Design Premium Black & Chrome	New Design Premium Black & Chrome
Grille Garnish	X	X	Silver	X	X
Bumper Emblem	"CRYSTA" Embossed	"CRYSTA" Embossed	Silver	Chrome	Chrome
Headlamp	Multireflector	Multireflector	Multireflector	Automatic LED Projector, Halogen with LED Clearance Lamp	Automatic LED Projector, Halogen with LED Clearance Lamp
Front Fog Lamp	X	X	With Silver Garnish	Halogen with Chrome Garnish	Halogen with Chrome Garnish
Wheels	Steel Wheel with Full Wheel Cap	Steel Wheel with Full Wheel Cap	Alloy Wheels	Alloy Wheels	Alloy Wheels
Outside Rear View Mirror	Body Coloured, Electric Adjust with Side Turn Indicators	Body Coloured, Electric Adjust with Side Turn Indicators	Body Coloured, Electric Adjust & Retract, Welcome Lights with Side Turn Indicators	Body Coloured, Electric Adjust & Retract, Welcome Lights with Side Turn Indicators	Chrome, Electric Adjust & Retract, Welcome Lights with Side Turn Indicators
Side P Mold	X	X	Chrome	X	X
Black-Out Door Frame	X	✓	With Side Visor Chrome	✓	✓
Door Outside Handle	Body Colour	Body Colour	Chrome	Chrome	Chrome
<b>INTERIOR</b>					
Indirect Blue Ambient Illumination	X	X	X	✓	✓
Steering Wheel	Urethane with Silver ornament	Urethane with Silver ornament	Urethane with Silver ornament	Leather Wrap with Silver ornament	Leather Wrap with Silver ornament
Speedometer	With Multi Information Display	With Multi Information Display	With Multi Information Display	Blue Illumination, 3D Design with TFT Multi Information Display & Illumination Control	Blue Illumination, 3D Design with TFT Multi Information Display & Illumination Control
Multi Information Display (MID)	Dot Type MID with Drive Information (Fuel Consumption, Cruising Range, Average Speed, Elapsed Time, ECO Indicator), Outside Temperature	Dot Type MID with Drive Information (Fuel Consumption, Cruising Range, Average Speed, Elapsed Time, ECO Indicator), Outside Temperature	Dot Type MID with Drive Information (Fuel Consumption, Cruising Range, Average Speed, Elapsed Time, ECO Indicator), Outside Temperature	TFT MID with Drive Information (Fuel Consumption, Cruising Range, Average Speed, Elapsed Time, ECO Drive Indicator & ECO Score, ECO Wallet), Outside Temperature, Audio Display, Phone Caller Display, Warning Message	TFT MID with Drive Information (Fuel Consumption, Cruising Range, Average Speed, Elapsed Time, ECO Drive Indicator & ECO Score, ECO Wallet, Cruise Control Display), Outside Temperature, Audio Display, Phone Caller Display, Warning Message
Shift Lever Knob	Urethane	Urethane	Leather Wrap with Chrome ornament (Hydrographic)	Leather Wrap with Chrome ornament	Leather Wrap with Chrome ornament
Door Inner Garnish	Material Colour	Material Colour	Front and Rear : Wood-finish	Front: Silver & Piano Black / Rear: Silver & Piano Black	Front: Silver & Piano Black / Rear: Silver & Wood-finish
<b>SEATS, COMFORT &amp; CONVENIENCE</b>					
Air Conditioner	Manual Control	Manual Control	Manual Control	Automatic Climate Control with Cool Start and Register Ornament	Automatic Climate Control with Cool Start and Register Ornament
Front Seat	Separate Seats with Slide & Recline	Separate Seats with Slide & Recline	Separate Seats with Slide & Recline, Driver Seat Height Adjust	Separate Seats with Slide & Recline, Driver Seat Height Adjust	Separate Seats with Slide & Recline, Driver Seat Height Adjust
B-Way Power Adjust Driver Seat	X	X	X	X	✓
Seat Material	Black Fabric	Black Fabric	Premium Black Fabric	Premium Black Fabric with stitched "CRYSTA" insignia	Option of Perforated Black OR Camel Tan Leather** with embossed "CRYSTA" insignia
Audio	X	Display Audio, Capacitive Touch Screen, Flick & Drag Function, Bluetooth	Display Audio, Capacitive Touch Screen, Flick & Drag Function, Bluetooth	Display Audio, Capacitive Touch Screen, Flick & Drag Function, Bluetooth	Display Audio, Capacitive Touch Screen, Flick & Drag Function, Bluetooth
Android Auto / Apple CarPlay	X	✓	✓	✓	✓
Accessory Connector 12V DC	2 N	2 N	2 N	2 N	2 N
Smart Entry System	X	X	X	✓	✓
Wireless Door Lock	With Jack-Knife Key	With Jack-Knife Key	With Jack-Knife Key	With Smart Entry Key & Push Start/Stop Button	With Smart Entry Key & Push Start/Stop Button
Easy Closer Back Door	X	X	X	X	✓
Cruise Control	X	X	X	✓	✓
Seat Back Pocket	X	X	With Shopping Hook	With Shopping Hook	With Shopping Hook
Seat Back Table	X	X	X	✓	With Wood-Finish Ornament
Tilt & Telescopic Steering Column	✓	✓	✓	✓	✓
<b>SAFETY &amp; SECURITY</b>					
SRS Air Bag**	Driver, Front Passenger & Driver Knee Airbags (3 U)	Driver, Front Passenger & Driver Knee Airbags (3 U)	Driver, Front Passenger & Driver Knee Airbags (3 U)	Driver, Front Passenger, Driver Knee, Front Side, Curtain Shield Airbags (7 U)	Driver, Front Passenger, Driver Knee, Front Side, Curtain Shield Airbags (7 U)
Seat Belt Reminder (2 <sup>nd</sup> & 3 <sup>rd</sup> Row Seats)	X	X	X	✓	✓
ABS with EBD & BA	✓	✓	✓	✓	✓
Vehicle Stability Control	✓	✓	✓	✓	✓
Hill Start Assist Control	✓	✓	✓	✓	✓
Back Monitor	X	X	With DVR	✓	✓
Front Clearance Sonar with MID Indication	X	X	X	✓	✓

\*Mix of Genuine and Synthetic Leather. \*\*For more details on the functioning of Airbags please refer to the owner's manual. \*\*\*Spare wheel material is Steel & Spare Tyre size is 205/65 R16 (40.64cm.). \*\*B56 Phase 2 Compliant.



Super White



Attitude Black Mica



Avant-Garde Bronze Metallic

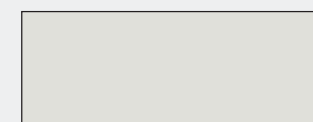

Platinum White Pearl

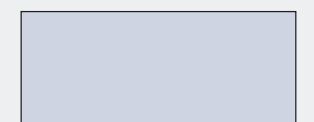

Silver Metallic

\*\*For more details on the functioning of Airbags please refer to the owner's manual.